

## ACCESSORIES

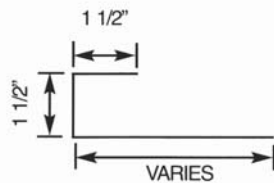

**CELL CLOSURE (20 GAGE MIN.)**

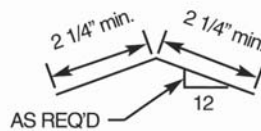

**RIDGE AND VALLEY PLATE (20 GAGE MIN.)**

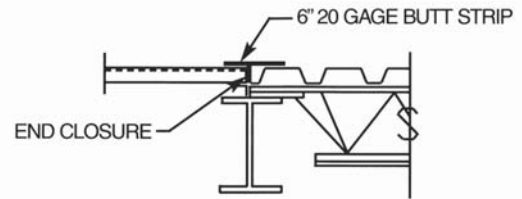

**DETAIL WHERE DECK CHANGES DIRECTION**



**WELDING WASHERS  
5/16" HOLE, 14 GAGE**

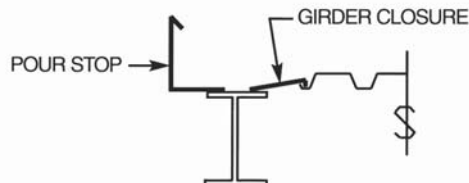

**TYPICAL POUR STOP AND GIRDER CLOSURE APPLICATION**

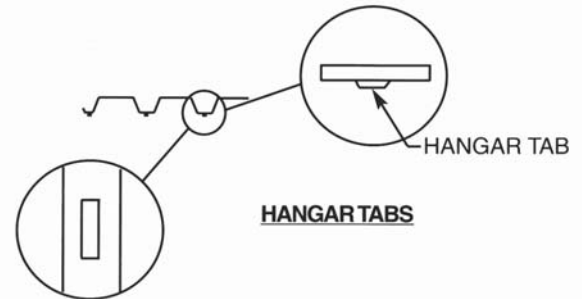

**HANGER TABS**

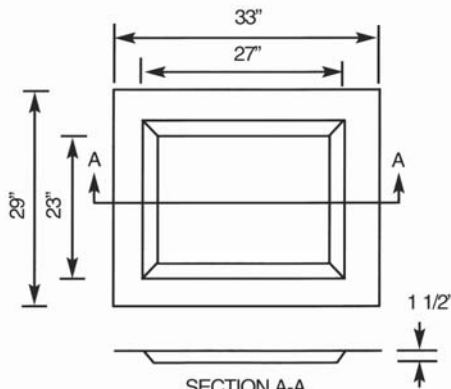

**SECTION A-A  
RECESSED SUMP PAN LEVEL (14 GAGE MIN.)  
(HOLE CUT IN FIELD BY OTHERS)**

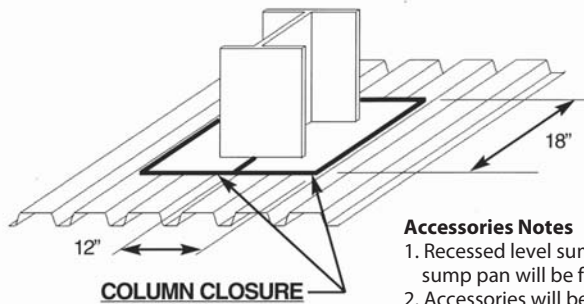

**COLUMN CLOSURE**

**Accessories Notes**

1. Recessed level sump pan is standard. Sloped sump pan will be furnished only when specified.
2. Accessories will be furnished in 10' lengths.
3. Accessories will only be furnished when ordered.
4. Tek screws are also available.
5. Hanger tabs available in all composite decks 20 gage and heavier.

## TYPICAL FASTENER LAYOUTS

**1.5", Types "B", "F", "A" and 1.5" Composite**

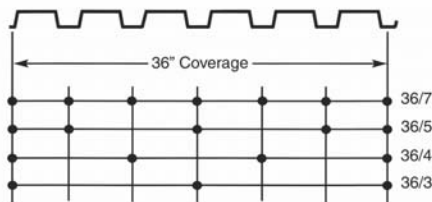

**3", Type "N"**

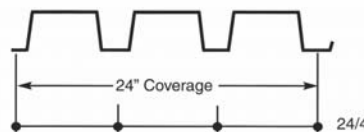

**9/16", Type "S"**

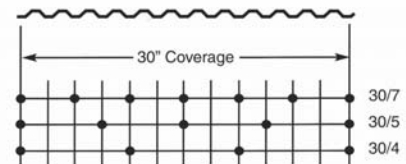

**2" Composite**



**7/8", Type "HD"**

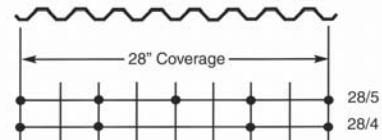

**3" Composite**

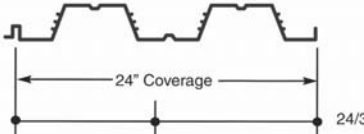

**Sidelap Fastening:**

In general, if spans are less than 5'-0" sidelap fastening is not required. If spans are greater than 5'-0", deck is to be fastened at midspan or every 36", whichever is smaller.

